

Define Your Horizon

[www.horizonyacht.com](http://www.horizonyacht.com)



HORIZON FD85



Original design from Cor D. Rover

FD85

Horizon FD85

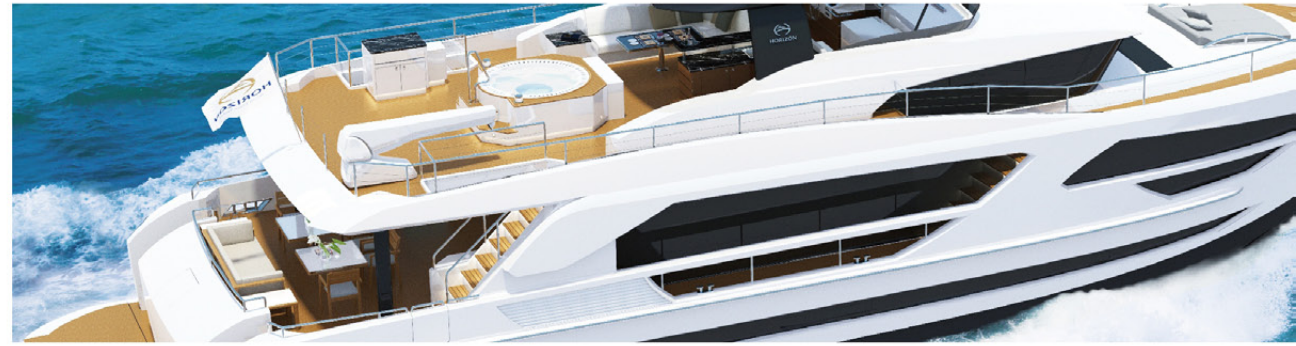

Dare to be Different

The New Horizon **FD85 Fast Displacement** Motoryacht

Highly **efficient & versatile** cruising capabilities

**Innovative design;** The **85** with a 100ft attitude

**Extensive interior & exterior volume**

**Modern styling;** Flexible performance

# WHY FD85

When Horizon Yachts began considering a new fast displacement, mid-range motoryacht, we knew the yacht needed to be safe, needed to be stylish, and needed to maximize the interior and exterior volume as much as possible. We see many clients who come to Horizon for a mid-size yacht and want to enjoy their yacht with family and friends; entertaining groups is an important factor in their layout choices, as is the ability for the owners to easily manage the yacht themselves. This is where the Horizon FD85 comes into play.



## Horizon FD85 Design Team

Cor. D. Rover, a world-renowned designer, collaborated with Horizon's in-house naval architects to develop the new Horizon FD85 – a truly advanced fast displacement motoryacht that incorporates modern flair with usable living and entertaining spaces that are comparable to most 100+ yachts.



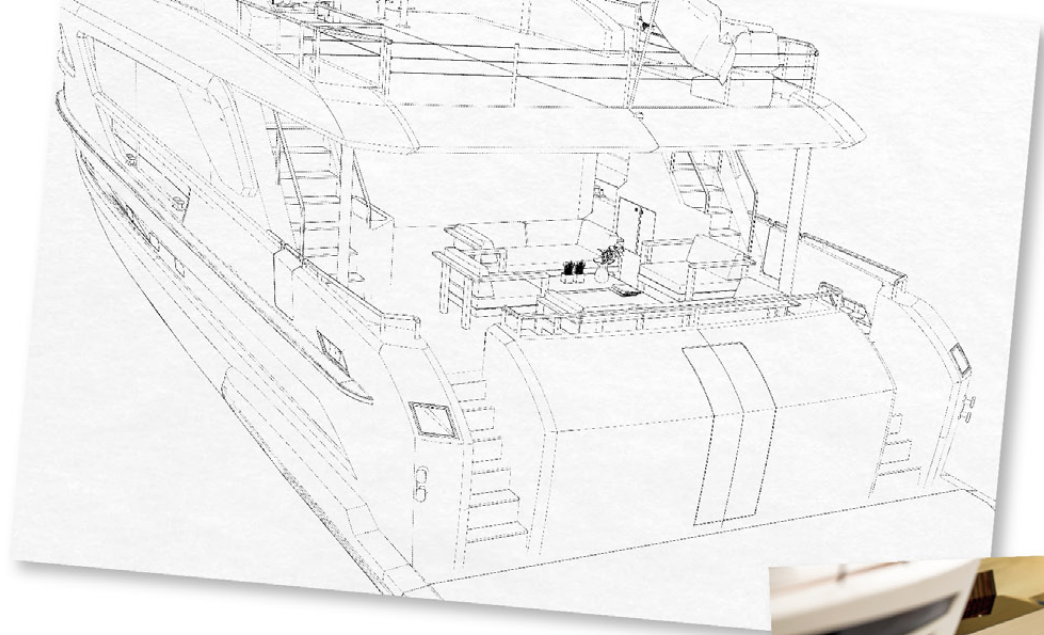

We have spent countless hours brainstorming, discussing, developing, and perfecting the details for the new Horizon FD85. The first of her kind in Horizon's luxury yacht collection, the FD85 encompasses the ultimate in versatile displacement motoryacht design.





The FD85 is currently in build and scheduled to debut at the 2016 Taiwan International Boat Show in Kaohsiung, March 10-13, 2016.

NEW FD85 NEW FD85 NEW FD85 NEW FD85 NEW FD85 NEW FD85 NEW FD85 NEW FD85

NEW FD85 NEW FD85 NEW FD85 NEW FD85 NEW FD85 NEW FD85 NEW FD85 NEW

NEW FD85 NEW FD85 NEW FD85 NEW FD85 NEW FD85 NEW FD85 NEW FD85 NEW FD85

NEW FD85 NEW FD85 NEW FD85 NEW FD85 NEW FD85 NEW FD85 NEW FD85



## *Revolutionary Design*

Contemporary style lines, creative interior spaces, tremendous interior volume, and flexible cruising speeds – these are the core features of the new Horizon FD85 fast displacement motoryacht. The FD85's exterior and interior layouts were designed to take full advantage the volume provided by her 23'3" beam, with separate areas for entertaining, relaxing, and enjoying the surroundings. A total of five en suite guest staterooms are on board -- a full-beam, on-deck master stateroom and four guest staterooms below deck – plus crew quarters just forward of the engine room.



## Technical Specifications



L.O.A.	: 85'- 3"	( 25.99M )
L.W.L.	: 73'- 2"	( 22.31M )
Beam	: 23'- 3"	( 7.07M )
Draft	: 5'-11"	( 1.80M )
Height (W.L. to top of arch)	: 31'-7"	( 9.64 M )
Displacement(light app.)	: 165,350 lbs	( 75 tons )
Fuel	: 2,700 US gal	( 10,200 ltrs )
Fresh Water	: 400US gallons	( 1500ltrs )
Engine	: Twin CAT C18 ACERT 1136HP	
Generator	: Twin x Onan 22.5 Kw(50Hz) or Twin x 29Kw(60Hz)	

\* Optional items may be included in the drawing and are for reference only.

HORIZON FD85

Master stateroom is situated on the main deck, allowing complete privacy.

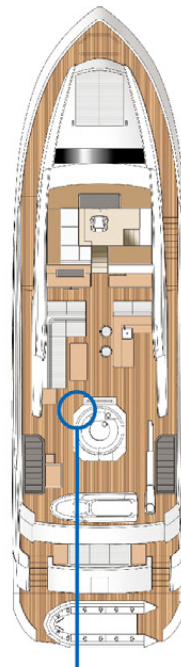

Flexible area for Jacuzzi or sun loungers.

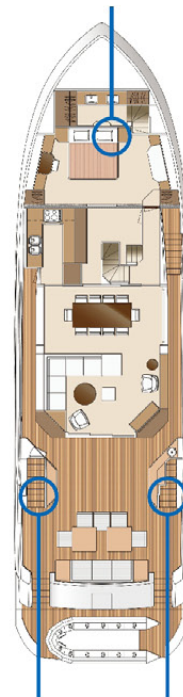

Twin staircases from the aft deck to the flybridge simplify access.



Insulation package affords a quieter atmosphere while cruising.



*Flexible Performance*

## Efficient Cruising Capabilities

A vertical bow design, hybrid hull shape and tunnel design delivers a more comfortable ride, lower resistance and excellent stability, while offering easy maneuverability and efficient speeds from 10 to 20 knots.

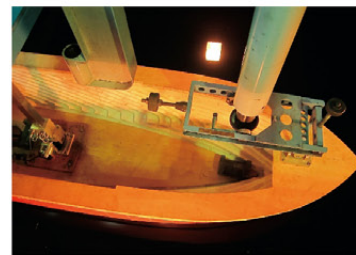
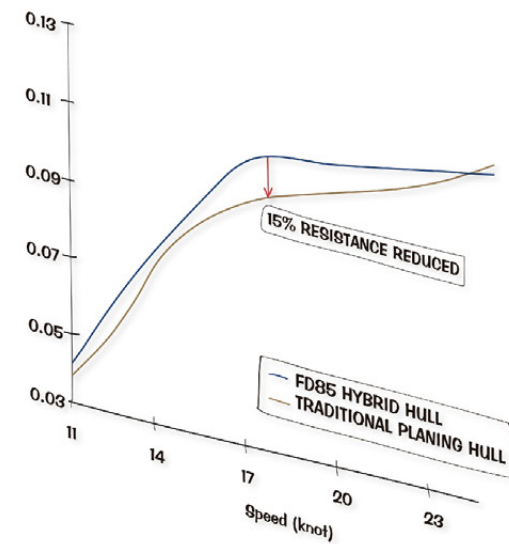

"For the new Horizon FD85, we specifically chose to focus on a hull form that affords flexible cruise speeds without compromising performance." said Horizon Yachts CEO John Lu.

## Alfresco Entertaining

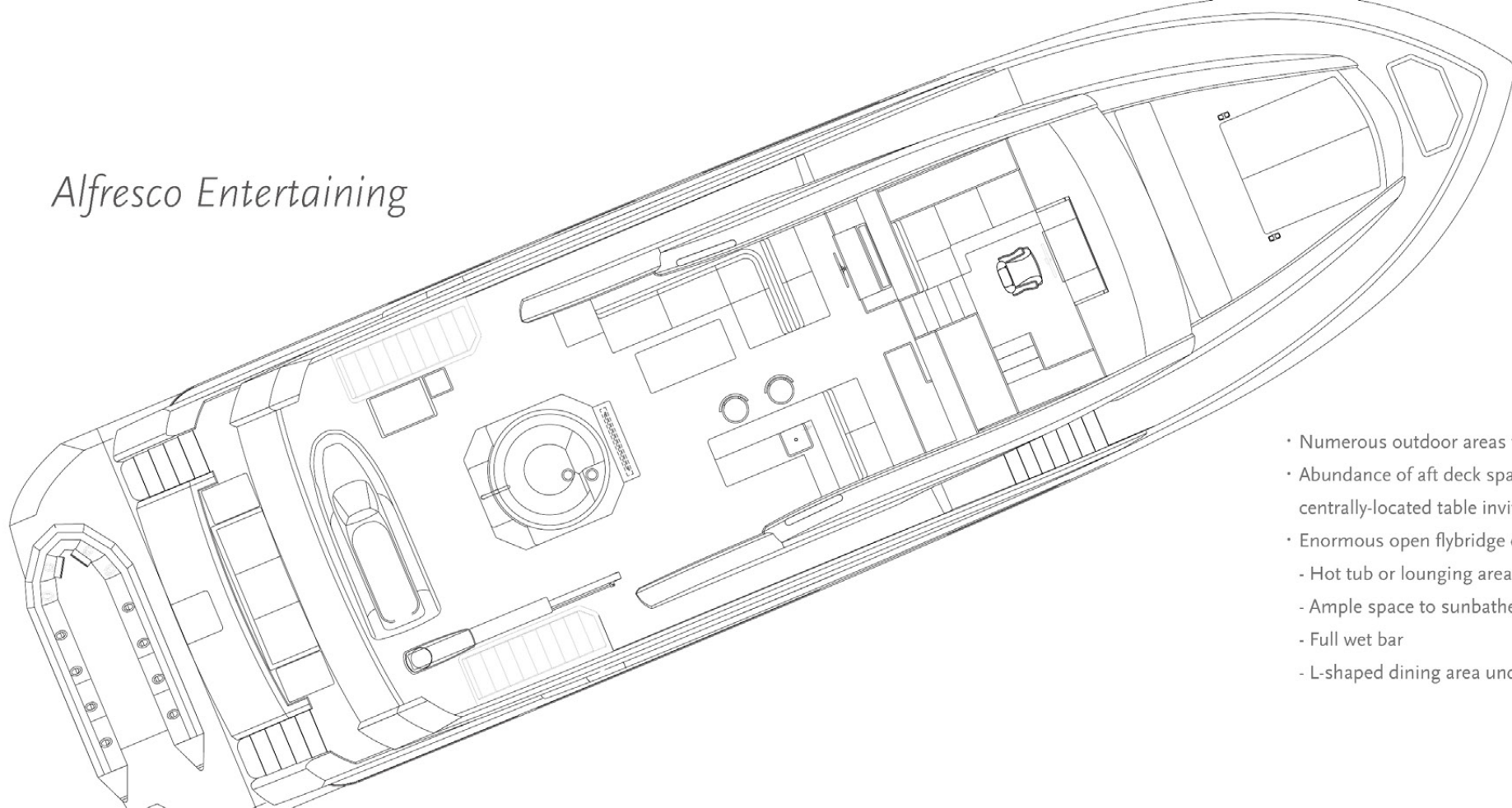

- Numerous outdoor areas for entertaining
- Abundance of aft deck space, great visibility, and a centrally-located table invite you to relax and take in the scenery
- Enormous open flybridge complete with:
  - Hot tub or lounging area
  - Ample space to sunbathe
  - Full wet bar
  - L-shaped dining area under custom hard top

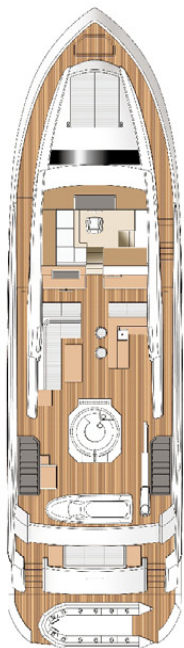

## *Aft Deck & Flybridge*

There are numerous outdoor entertaining areas on the new Horizon FD85. Large aft deck space, great visibility, and a centrally-located table invite you to relax and take in the scenery; an enormous open flybridge features a hot tub, ample space to sunbathe, double-layer bar and L-shaped seats under the custom hard top.





A detailed architectural floor plan of the Horizon FD85 yacht, showing the deck and cabin layout. The plan includes a large central living area with a sofa, coffee table, and armchairs. A dining table with chairs is positioned nearby. The kitchen area is located at the top right, featuring a sink, stove, and refrigerator. A master stateroom is situated at the bottom right, with an en suite head. Four additional guest staterooms are located below deck, and crew quarters are positioned just forward of the engines. The deck features a full beam master stateroom with an en suite head, and a large area of floor-to-ceiling glass windows. The yacht's hull is shown on the right side of the plan.

*Extensive Volume Inside & Out*

- 25% increase in volume over yachts with similar LOA's
- Large areas of floor-to-ceiling glass windows, which create a feeling of being at one with nature
- Full beam, on-deck master stateroom with en suite head
- Four additional en suite guest staterooms below deck, along with separate crew quarters just forward of the engines





## Main Deck

The Horizon FD85's exterior and interior layouts were designed to take full advantage of her extensive volume, providing separate areas for entertaining, relaxing, and enjoying the surroundings.





Large areas of floor-to-ceiling glass windows provide natural light, a major theme of the FD85.



## *Below Deck*

Four additional guest staterooms are found below deck, along with separate crew quarters just forward of the engines.



*Relax in Complete Privacy*



HORIZON FD85



FD85

## Our Core Values

**10** th consecutive winner of " Best Asian Yacht Builder " Award

Only top **5** custom luxury yacht builder in Asia

Highest number of superyachts delivered among all Asia shipyards, totaling over **165**

Recognized as one of the Top **10** Global Superyacht Companies by The Superyacht Report

Only shipyard to receive **2** Taiwan Excellence Gold Awards

**Only** SYBAss member in Asia

**8** yacht series with more than **20** models to choose from

**800** professional yacht builders and more than **300** master craftsmen

Horizon sales and support to clients in over **60** countries

**30** years of professional experience building luxury yachts

Over **110,000** m<sup>2</sup> (1,183,600 sq ft) area, with **4** specialized shipyards for building our yachts





## 2015 ShowBoats GLOBAL ORDER BOOK

### TOP 30 BUILDERS

Rank	Company	Total (m)	Total (ft)	New Build Projects	Avg. (ft)	New Build Projects 2014	2014 Rank
1	Benetti	2,555	8,383	66	127	79	1
2	Benetti	1,690	5,545	48	116	39	2
3	Benetti	5,089	16,700	49	104	32	3
4	Benetti	3,550	11,647	36	99	26	5
5	Benetti	2,881	9,454	9	320	7	6
6	Benetti	2,602	8,573	12	217	10	7
7	Benetti	2,375	7,808	12	198	8	8
8	Princess Yachts	2,323	7,621	25	93	30	4
9	Heesen Yachts	565	1,854	11	169	10	13
<b>10</b>	<b>Horizon</b>	<b>514</b>	<b>1,686</b>	<b>16</b>	<b>105</b>	<b>16</b>	<b>11</b>
11	Gulf Craft	468	1,535	13	118	15	10
12	Fipa Group	442	1,450	12	121	9	16
13	Overmarine	430	1,411	12	118	14	9
14	Alexander Marine	428	1,404	15	94	11	22
15	Oceanco	392	1,286	4	322	5	12
16	Christensen	360	1,181	8	148	8	15
17	Cerri - Baglietto	303	994	7	142	9	17

## Horizon at the Top

The 2015 Global Order Book (GOB), compiled by ShowBoats International magazine, provides an annual data report for yacht build and sales activity throughout the globe on yachts 80 feet in length and longer. Horizon is proud to rank number 10 in the 2015 GOB list of Top 30 Builders by length worldwide.

Horizon builds yachts that satisfy owner lifestyles from around the world – we are dedicated to providing our clients with safe, high quality luxury yachts and complete after-sales service no matter where you are.

# Horizon Achievements

## SYBAss

SUPERYACHT BUILDERS ASSOCIATION

### SUPERYACHT BUILDERS ASSOCIATION

Since 1987, Horizon Group has delivered 165 superyachts, which is the largest number delivered by any yacht builder in Asia. We joined SYBAss in 2010 and remain the only qualified luxury yacht builder and SYBAss member in the Far East to date. Horizon's superior yacht quality and advanced build technology is highly competitive with other top superyacht builders around the globe, and we also actively promote the superyacht lifestyle and experience as members of SYBAss.

[www.sybass.org](http://www.sybass.org)



### THE WORLD SUPERYACHT AWARDS

The World Superyacht Awards is the most prestigious awards programs for superyachts over 100 feet. Each year, a panel of judges selects the best 100+ superyachts, within various categories, that have been delivered to their owners within the past year. In 2009 the Horizon P130 "Miss Rose" was selected as a Finalist, and in 2010 the Horizon RP120 "Espresso" was Finalist; the Horizon RP120 "Muses" and P136 "Angara" were both 2012 Finalists. The Horizon RP110 "Esther 7" was a Finalist in the 2015 World Superyacht Awards.

[www.worldsuperyachtawards.com](http://www.worldsuperyachtawards.com)



### ASIA BOATING AWARDS

Founded in 2005, the Asia Boating Awards recognizes and selects the best performing shipyards and their outstanding achievements within the Asian yachting industry for the past year. Horizon is the only Taiwan yacht builder with an unbreakable record of 10 consecutive "Best Asian Yacht Builder" awards since 2006. Horizon Group CEO John Lu received the "Personality of the Year" award in 2015. The Asia Boating Awards is an annual event organized by famous Asian yacht magazines Asia Pacific Boating and China Boating.

[www.asiaboatingawards.com](http://www.asiaboatingawards.com)



### TAIWAN EXCELLENCE

Taiwan Excellence is the premier award for "made in Taiwan" products and is presented only to revolutionary, high quality, and high value products. The Gold Award, which is the highest honor that a company can achieve within Taiwan Excellence, is selected by expert judges, who must review over 1,000 Taiwan products and select the top 10. Horizon received our first Taiwan Excellence award in 2010, and we have won an award each subsequent year for our yachts and their outstanding performance and features. In 2015, the Horizon PC60 power catamaran was awarded our seventh Taiwan Excellence award, and she was also the recipient of our second Gold Award; the EP148 expedition yacht was a Gold Award winner in 2014.

[www.brandingtaiwan.org/TaiwanExcellence/en/index.aspx](http://www.brandingtaiwan.org/TaiwanExcellence/en/index.aspx)

HORIZON FD85







Define Your Horizon



DYNAMIC BOATS | TZALAVRAS  
SINCE 1980 ALWAYS AHEAD

HELLAS | CYPRUS | TURKEY

DC: 307 Varis – Koropiou Av.  
& Kolokotroni str.  
194 00, Koropi  
Athens, Hellas  
HQ: 12, Tompazi str.  
17456, Alimos,  
Athens, Hellas  
T: +30 210 96 56 641  
F: +30 210 96 56 643  
info@dynamicboats.gr  
www.dynamicboats.gr